



## SLIT LAMP IMAGING GUIDE

Superior technology – reliable instruments

Look closer. See further.

 **HAAG-STREIT**  
DIAGNOSTICS

## SLIT LAMP IMAGING GUIDE

# Preamble

## Slit lamp microscopy

On August 3<sup>rd</sup>, 1911, Alvar Gullstrand introduced the first rudimentary model of the slit lamp illuminator.

An occasion of tremendous significance to ophthalmology had just taken place. Gullstrand described a device with the potential to advance the understanding of the eye and its problems as profoundly as did the direct ophthalmoscope 50 years earlier. By 1916, Henker had developed a practical combination of Gullstrand's illuminator and Czapski's corneal microscope, marking the first major advance in methods of examining the external eye in more than a century. In 1936 Comberg established the co-pivotal and iso-centric relationship between the microscope and slit illuminator and, in 1938, Goldmann's collaboration with Haag-Streit produced the first par-focal instrument which also featured the single control lever design in use to this day. Goldmann also influenced the shift to Köhler illumination, greatly improving the efficiency of the slit lamp illuminator, the very heart of this marvellous device.

These significant milestones, with contributions from a host of other individuals, have coalesced into the highly sophisticated instruments that are placed at our disposal today. In light of such capabilities in instrumentation, it follows that our results in slit lamp examination and slit lamp photography will rest on the level of sophistication we apply to the practice of these challenging and stimulating art forms.

Csaba L. Mártonyi, COPRA, CRA/Emeritus Associate Professor/University of Michigan, Ann Arbor

## Haag-Streit imaging guide

This guide is intended to assist all those who seek to capture images of the eye, using the slit lamp, to improve the quality of their photography by using simple to follow illumination diagrams and high quality image examples. We hope this book provides inspiration and motivation to anyone who is involved in the art of documenting the unique properties and pathologies of the eye and through Haag-Streit we offer a number of instruments to help you.

Haag-Streit greatly appreciates and thanks all those who have contributed to this publication.



# Content

Physical and optical conditions .....	05
Types of illumination .....	05
Diffuse illumination .....	05
Direct focal illumination .....	05
Indirect illumination .....	05
Retroillumination .....	05
Photography with three-mirror contact lens or 90-diopter lens .....	05
Pictograms .....	05
Imaging Module IM 910 on BQ 900 .....	06
Freeze Technology .....	07
History Trigger .....	07
Easy touch .....	07
Depth of field control (DFC) – Aperture .....	07
Image exposure guide for IM 910 .....	08
Overview – Diffuse illumination .....	08
Conjunctiva – Diffuse illumination .....	08
Cornea – Narrow slit .....	08
Cornea – Moderate slit .....	08
Cornea – Tangential illumination .....	09
Cornea – Retroillumination .....	09
Lens – Narrow slit .....	09
Lens – Wide slit .....	09
Lens – Retroillumination .....	10
Iris – Tangential illumination .....	10
Fundus .....	10
BX 900 photo slit lamp .....	11
Technical data .....	12
Standard settings .....	13
Illumination and exposure settings .....	13
Pictograms .....	13
Diffuse illumination with slit and background illumination .....	13
Diffuse illumination with background illumination only .....	14
Lids – Diffuse illumination .....	14
Conjunctiva – Diffuse illumination .....	14
Conjunctiva – Narrow slit .....	15
Conjunctiva – indirect illumination .....	15
Cornea – Diffuse illumination .....	15
Cornea – Wide slit, tangential illumination .....	16
Cornea – Moderate slit .....	16
Cornea – Narrow slit, optical sectioning .....	16
Cornea – Direct retroillumination from the iris .....	17
Cornea – Indirect retroillumination from the iris .....	17
Cornea – Sclerotic scatter .....	17
Cornea – Topical administration of Sodium Fluorescein .....	18
Anterior chamber – Aqueous flare, Tyndall's phenomenon .....	18
Anterior chamber – Goniophotography .....	18
Iris – Wide slit, tangential illumination .....	19
Iris – Transillumination .....	19
Iris Angiography .....	19
Lens – Narrow slit, optical sectioning .....	20
Lens – Moderate slit, direct illumination .....	20
Lens – Moderate slit, tangential illumination .....	20
Lens – Retroillumination, red-reflex photography .....	21
Vitreous – Narrow slit .....	21
Fundus – Central retina with a three-Mirror contact lens .....	21
Fundus – Central retina with a 90-diopter lens .....	22

# Physical and optical conditions

The binocular examination of the eyes with the slit lamp takes place in a three-dimensional space with great depth of field. Normal slit lamp imaging is a two-dimensional documentation with a very small depth of field. The difference between the dynamic, stereoscopic clinical examination and the static two dimensional image can be surprising and often disappointing. The use of this guide will tackle this issue and help users create high quality images.

Haag-Streit has developed specific imaging eyepieces with a cross hair which are available for all Haag-Streit imaging systems.

The accommodative abilities of the photographer's own eye are normally not noticeable during examination. However it is important that the photographer establishes the correct eyepiece setting to compensate for any accommodation or refractive errors. Only viewing a sharp image of the cross hair overlaying a focused image of the eye ensures capturing of a sharply focused image.

It should also be considered that the examiner's attention is focused on the details that are of interest and by selective viewing the brain suppresses certain artefacts. The camera however does not!

## Types of illumination

The correct illumination will allow optimal recording of ocular pathology.

### Diffuse illumination

The slit lamp beam should be completely opened and covered by the diffusing filter. The background illumination can be used in conjunction with the slit illumination for more uniform lighting. The diffuse illumination is normally used for overview pictures with low magnification (10x and 16x).

### Direct focal illumination

Direct focal illumination refers to projecting the light on the subject at the plane of focus. Unlike diffused light, concentrated light penetrates transparent structures. With a centred slit beam there is always direct focal illumination.

### Indirect illumination

With indirect illumination the light does not fall directly on the pathology. The slit beam is decentered and projected just adjacent to the subject area and it is illuminated by scattered internally reflected light.

### Retroillumination

Retroillumination is a form of indirect illumination. Light reflected from the fundus or iris illuminates the pathology from behind. If the slit beam is decentered and higher magnification is used, unwanted reflections can be minimized.

### Photography with three-mirror contact lens or 90-diopter lens

With these instruments there are more optical interfaces (air/glass and glass/cornea). All interfaces cause reflexes and therefore it is better to take images without the background illumination. Furthermore any scratches or damage to the lens will increase the number of image artefacts. If the space between the diagnostic contact lens and the slit illuminator is very small, the background illumination can be locked in the centre position.

## Pictograms

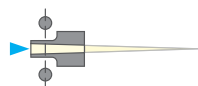

Narrow slit beam

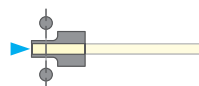

Moderate slit beam

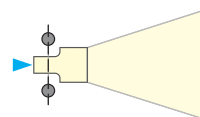

Wide slit beam

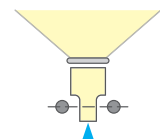

Slit beam with diffusor

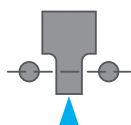

Slit beam centred

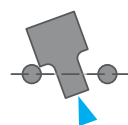

Slit beam decentered

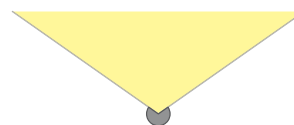

Background illumination



Microscope

# Slit lamp BQ 900 and Imaging Module 910

1. LED illumination head
2. Background illumination
3. Eyepiece with double cross hair reticule
4. Knob for beam splitter/camera on-off
5. Aperture control knob
6. Magnification changer
7. Diffusor
8. Imaging Module 910
9. Shutter-release
10. Illumination control
11. Background illumination control

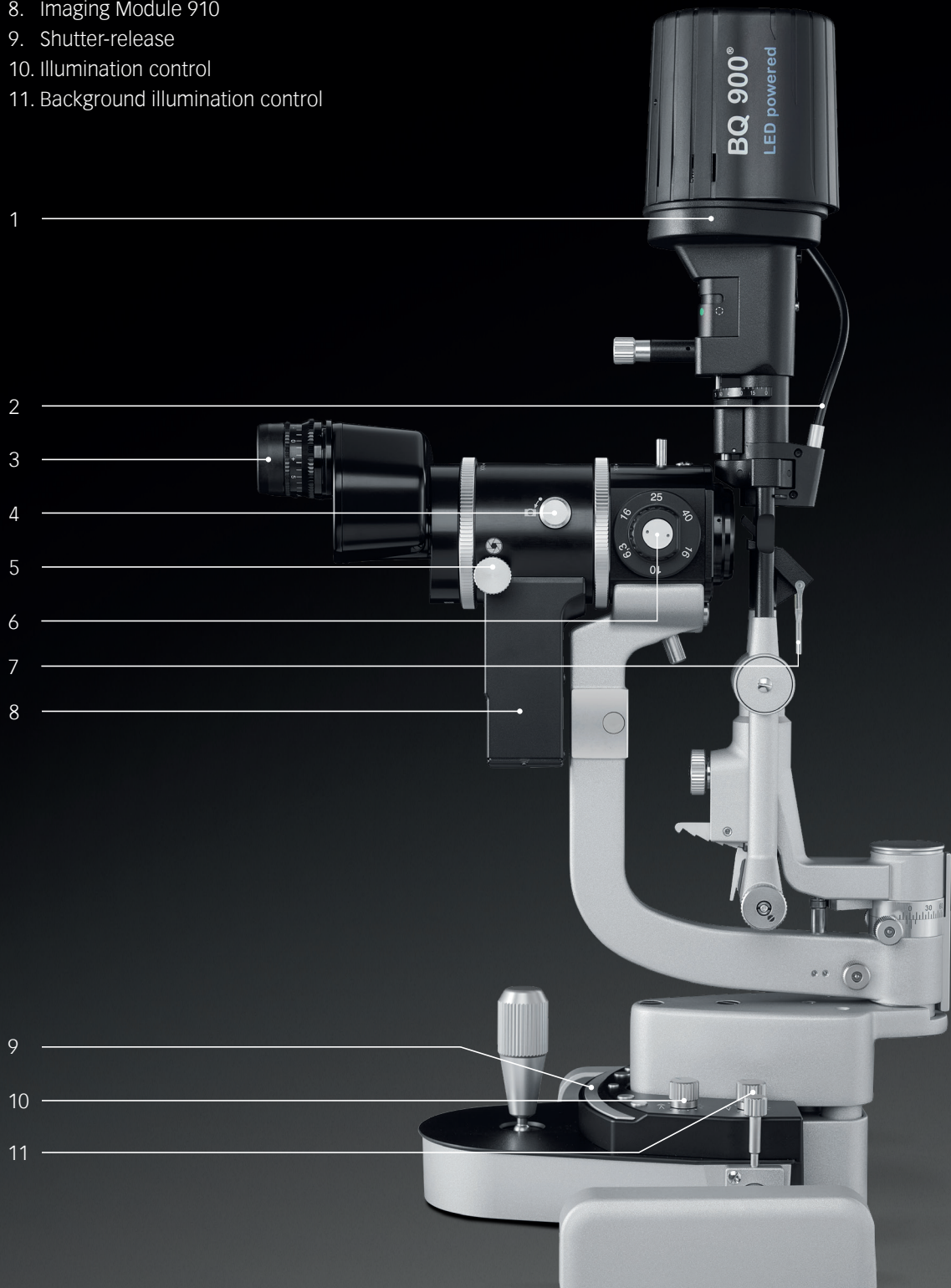

# Imaging Module IM 910

## Slit lamp documentation at the push of a button

Rely on the leader of slit lamp imaging and let the Imaging Module 910 take care of the details, so you can be confident you are getting outstanding and expressive images while concentrating fully on examining your patients.

### Ready when you are!

The Imaging Module 910 is instantly ready when you need it.

Finally, the days of cumbersome slit lamp imaging are over. By the turn of a knob, the Imaging Module 910 shares your view within your microscope directly on your screen – instantly!

Capturing images is equally easy – when you decide to document a finding, press the camera trigger button, and the software takes care of the rest. Simply switch off the camera after image capturing and get 100% light in the eyepieces again.

### Work the way you want

We believe that tools should adapt to your needs and not vice versa. For this reason, the Imaging Module 910 can be used in different ways and integrated into many different environments.

Whether you are in «standalone mode» storing your images directly to your EMR, or in «EyeSuite mode» which is fully integrated into the EyeSuite software, the Imaging Module 910 always gives you brilliant and meaningful images at the push of a button.

### A striking image with every shot

The camera sensor and the superb optics of the Imaging Module 910 provide you with outstanding image quality - but that's not all.

With conventional slit lamp cameras, the success rate of conclusive images is often disappointing. To overcome this, the Imaging Module 910 provides you with smart features that are at work for you in the background. A performant auto-exposure mode in combination with the automatic aperture control guarantees great illumination at all time. In addition, the image selection algorithm ensures that you get the sharpest and most expressive image possible. Simply concentrate on your examination and let the Imaging Module 910 do the rest.



IMAGING MODULE 910



READY WHEN YOU ARE!



WORK THE WAY YOU WANT



EVERY SHOT AN EXPRESSIVE IMAGE

# Image exposure guide for IM 900

## Overview – Diffuse illumination

Magnification	10x or 16x
Slit illumination	open, 45°, diffused
Slit illumination level	4
Background level	3
Aperture	6
EyeSuite exposure	auto-mode

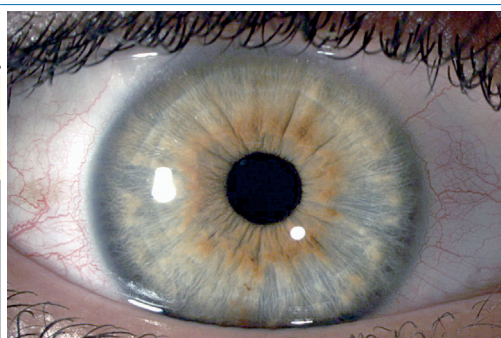
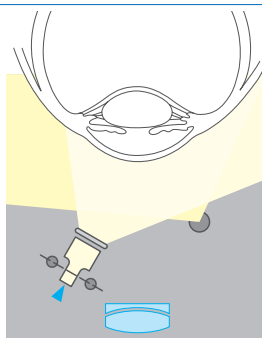

The diffuse illumination with slit beam and background illumination gives a shadow-free illumination with natural colors and two light reflexes. This is most useful for low magnification overview images.

## Conjunctiva – Diffuse illumination

Magnification	10x or 16x
Slit illumination	open, 45°, diffused
Slit illumination level	3
Background level	3
Aperture	6
EyeSuite exposure	auto-mode

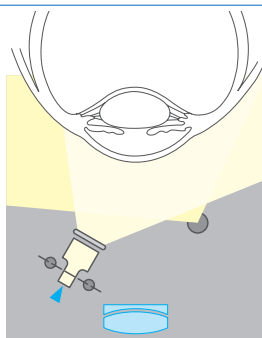

Diffuse illumination provides evenly balanced lighting. Exposure control is more varied due to increased reflectivity.

## Cornea – Narrow slit

Magnification	16x or 25x
Slit illumination	<0.2mm wide, >60 degrees from microscope
Slit illumination level	10
Background level	1
Aperture	3
EyeSuite exposure	auto-mode

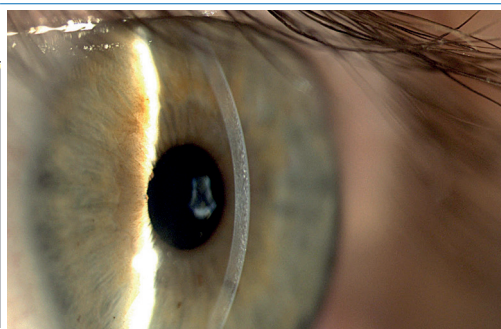
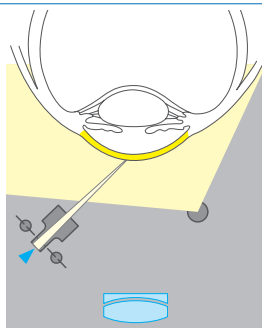

A narrow focal slit beam is projected at a 45° to 60° angle. It cuts an optical section through the cornea like a knife. With this technique it is possible to locate the layer of the pathological changes.

## Cornea – Moderate slit

Magnification	16x or 25x
Slit illumination	1–2mm wide, >60 degrees from microscope
Slit illumination level	10
Background level	1
Aperture	4
EyeSuite exposure	auto-mode

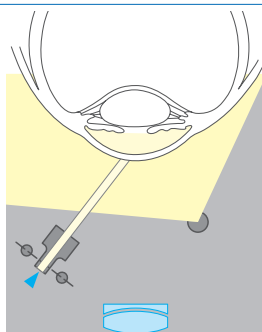

The moderate beam produces two different layers of illumination, one on the epithelium and one on the endothelium.



## Cornea – Tangential illumination

Magnification	16x or 25x
Slit illumination	>4 mm wide, >60 degrees from microscope
Slit illumination level	10
Background level	off
Aperture	6
EyeSuite exposure	auto-mode

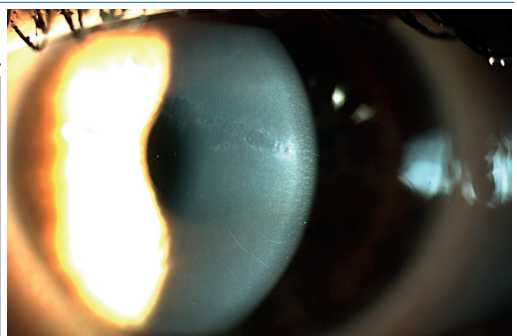
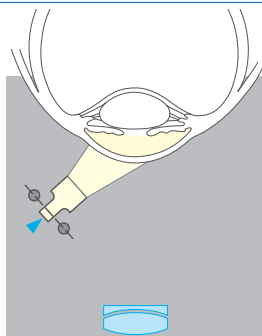

This technique can provide more information as the oblique illumination is reflected and refracted by the cornea and any pathology. Experiment with the illumination angle slit beam width for optimum results.

## Cornea – Retroillumination

Magnification	16x or 25x
Slit illumination	1–3mm wide, decentred
Slit illumination level	10
Background level	off
Aperture	5
EyeSuite exposure	auto-mode

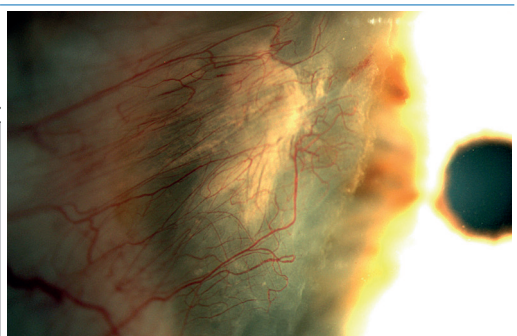
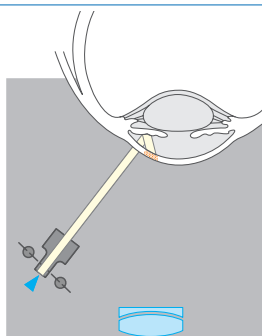

A moderate slit beam is decentred and angled to project onto the iris directly behind the pathology. The light reflects and backlights the cornea. If there is some cataract present the lens can also be used to reflect light directly onto the area of interest.

## Lens – Narrow slit

Magnification	16x or 25x
Slit illumination	<0.2 mm wide >60 degrees from microscope
Slit illumination level	10
Background level	1
Aperture	4
EyeSuite exposure	auto-mode

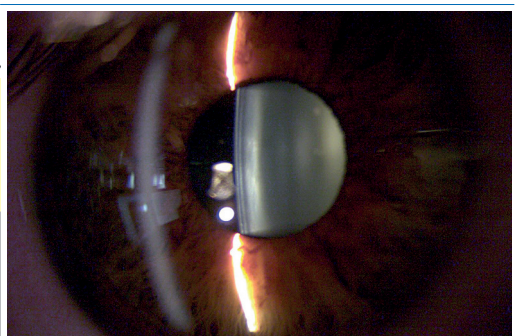
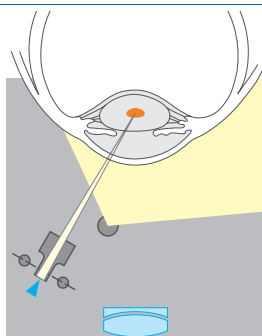

A narrow focal slit beam is projected at a 45° angle to the lens as an optical section is made. Because of the problematic depth of field it is not possible to photograph the entire lens section in focus. It is therefore necessary to focus on the anterior or the posterior lens surface.

## Lens – Moderate slit

Magnification	16x or 25x
Slit illumination	2–4 mm wide, >60 degrees from microscope
Slit illumination level	10
Background level	1
Aperture	6
EyeSuite exposure	auto-mode

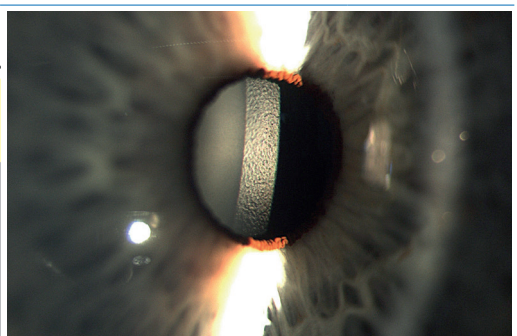
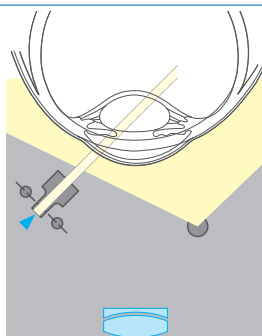

A moderate slit beam is projected at a 45° angle to the lens pathology and is directly illuminated.

## Lens – Retroillumination

Magnification	16 x, 25 x or 40 x
Slit illumination level	1–2 mm wide, <5 degrees
Slit illumination level	5
Background level	off
Aperture	5
EyeSuite exposure	auto-mode

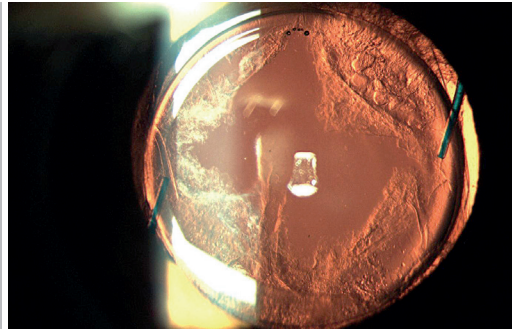
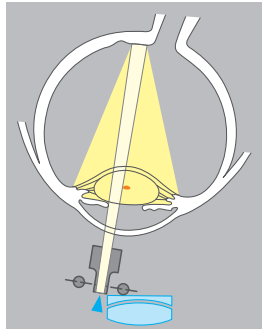

The slit illuminator is positioned in an almost coaxial position with the biomicroscope. A wide slit beam is decentred and adjusted to a half circle by using the slit width and height controls. The decentred slit beam is projected near the pupil margin through a dilated pupil. Careful composition can minimise the direct reflection.

## Iris – Tangential illumination

Magnification	16 x or 25 x
Slit illumination	Wide open, >60 degrees from microscope
Slit illumination level	10
Background level	off
Aperture	6
EyeSuite exposure	auto-mode

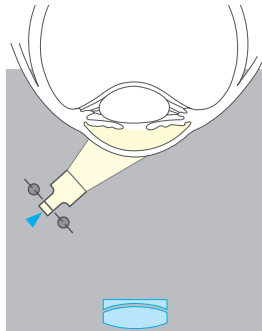

The wide slit beam is projected at an oblique angle of 80°–90° onto the iris. This illumination creates strong shadows and the surface texture is enhanced. If the headrest doesn't allow a wide oblique angle it is sometimes necessary to turn the patient's head a little away from the light.

## Fundus

Magnification	10 x or 16 x
Slit illumination	2–4 mm wide
Slit illumination level	5
Background level	off
Aperture	5
EyeSuite exposure	auto-mode

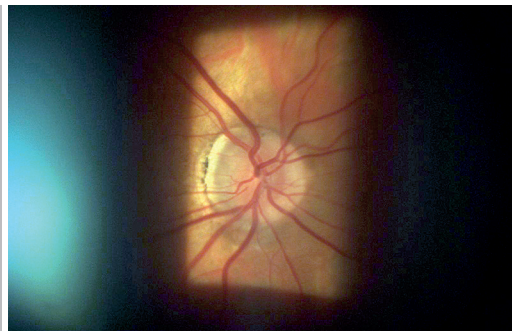
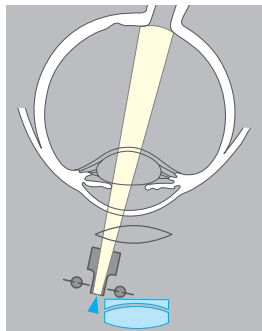

A moderate slit beam in the almost coaxial position gives the best results.

## Haag-Streit educational video

Haag-Streit has produced a short movie which helps you to get the most out of your new camera.

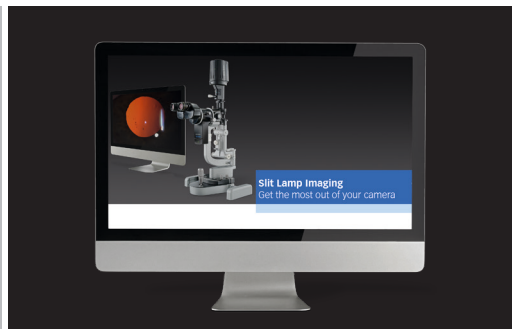

Visit our homepage under [www.haag-streit.com](http://www.haag-streit.com)

# BX 900 photo-slit lamp

1. Flash and LED illumination housing
2. Cable guide
3. Flash intensity changer for background illumination
4. Camera body
5. Objective tube
6. Eyepiece with double cross hair reticule
7. Mirror and diffusion filter
8. Mirror housing
9. Background illumination
10. Shutter release bar
11. Photo control unit

The Haag-Streit photo-slit lamp BX 900 is based on the slit lamp BQ 900. It is therefore possible to use the same instrument both for ocular examination and documentation. A photo-slit lamp is a combination of a biomicroscope, and illumination system and the photo attachment. The photo-slit lamp BX 900 and the Slit lamp BQ 900 share the same microscope. The illumination system of the photo-slit lamp has in addition a flash unit and a background illumination.

The different components will be explained on the following page.

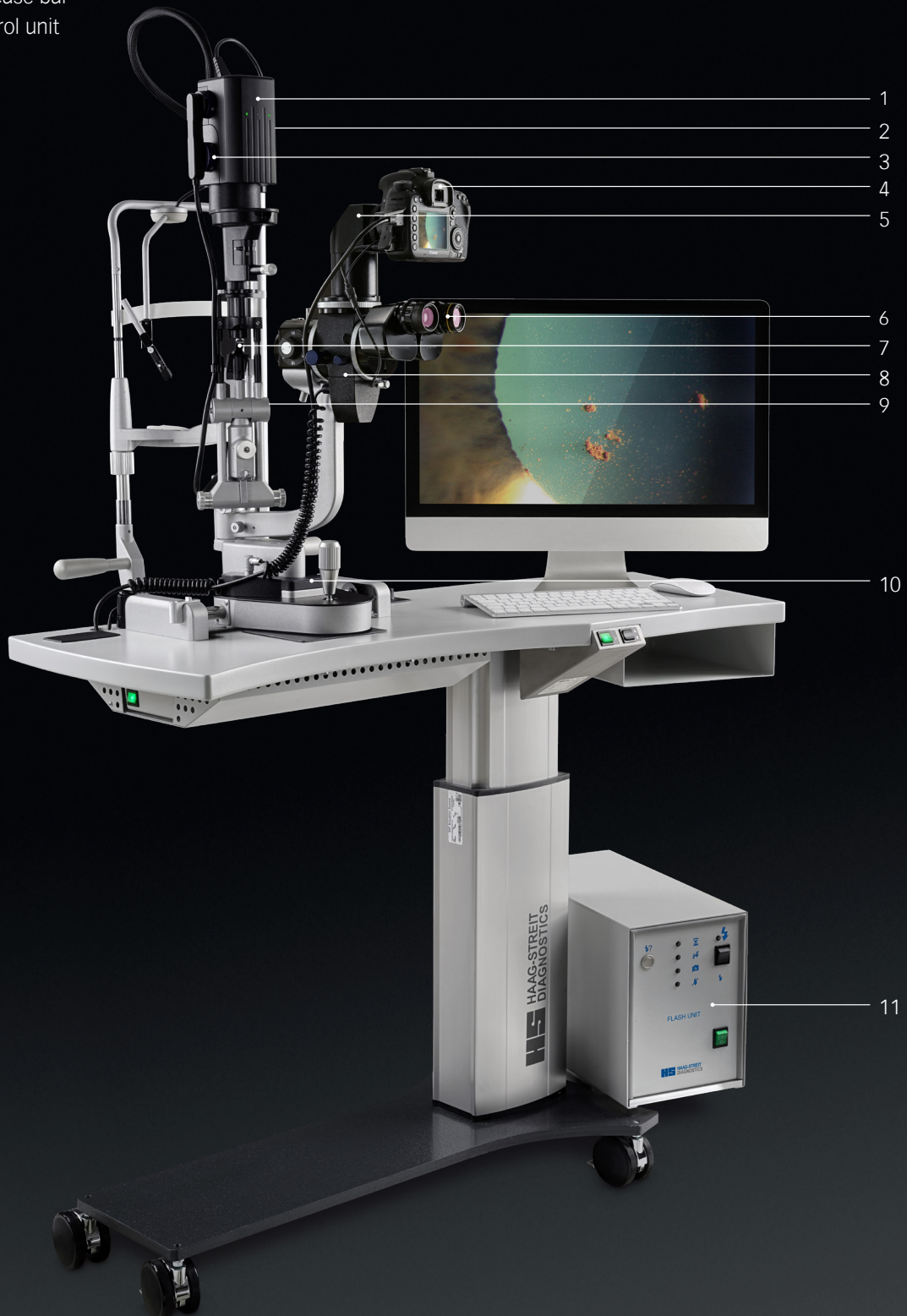

1. The flash housing contains the flash tube. Firing the BX 900 trigger will simultaneously deliver a flash through the illumination system and, via a glass fibre cable, the fill background illumination, while synchronizing with the camera shutter.

2. The cable guide contains the high voltage cable for the flash light.

3. The Flash intensity changer for the background illumination has seven settings:



4. Haag-Streit has selected a number of SLR cameras and has made the necessary adaptations. The correct function of the photo-slit lamp is guaranteed only by the use of cameras that are recommended by Haag-Streit. Note that the camera has to be in the «MANUAL» operating mode and the shutter speed should be set to 1/125 sec. The recommended ISO rating for general use is 500 and color temperature of the flash is 6000 k but users have the option to apply other settings as required.

5. The camera body is mounted on the objective tube on the top of the biomicroscope allowing full visibility of the patient's eyes from either side of the microscope.

6. The 12.5x eyepiece with double cross hair reticule is inserted into the right ocular of the microscope. This must be correctly focused for the user's eye to ensure sharp images are captured. Note that the setting on the eyepiece is not the user's refractive error.

7. With the diffusion filter the slit beam can be covered allowing overview pictures with diffuse illumination.

8. The principal component of the Haag-Streit photo-slit lamp BX 900 is the mirror housing with its built-in diaphragms. It mounts between the magnification changer and the binocular tube. When capturing an image all light is directed, via a mirror, to the camera. This allows the maximum utilisation of the available light: 100% for the examination and 100% for the image. The built-in diaphragm setting with five apertures is applied automatically on image capture. For the aperture intervals: Step 1 = largest aperture, Step 5 = smallest aperture. The small knobs on each side of the mirror housing can be used during examination to quickly activate the diaphragm to the preset position. This allows a preview prior to capture so that the image subject and depth of field may be checked.

9. The background illumination is swivel-mounted on a horizontal level and is illuminated through a glass fibre cable. The flash fill illumination is delivered from the illumination head and the modeling light is produced by the LED. The modelling light is used to show where any reflection of the fill flash will fall.

10. The shutter release bar is conveniently positioned in front of the joystick on the cross-slide. It can be used either right or left-handed.

11. The photo control unit is mounted under the left hand side of the table. On the front side there are two switches and four error light indicators. The power switch is only for the photo control unit. With the flash-intensity switch in the high position, the flash light increases by one aperture step. Optical and acoustic warning signals will be activated in the case of an error when the shutter release bar is pressed. Once the cause of the problem has been removed, press the shutter release bar and the optical warning signal will be cancelled and the camera will be ready for use.

## Technical data

### Biomicroscope

Magnification changer	6.3x, 10x, 16x, 25x, 40x
Ocular magnification	12.5x
Range of adjusting oculars	+7 to -7 dioptries
Reticule	Right ocular
Inter-pupillary distance	52 – 78mm

### Slit lamp illumination

Slit height	1–8mm
Slit width	0–8mm
Spotlight	0.2, 1, 2, 3, 5, 8mm diameter
Horizontal arc	+/-90°
Vertical arc	5°, 10°, 15°, 20°
Filters	Blue, green (red free), grey 10%
Slit beam diffuser	Yes
Light source	LED 24 VDC / 1 A

### Photo attachment

Image delivery	Quick return mirror 100% light for examination or photography
Objective tube focal length	170mm
Light source flash light	Normal 200Ws, high 400Ws

### Depth of field

Dependent on magnification and aperture.

Magnification    Extent of focus (+/- in mm) with aperture





	1	2	3	4	5
6.3x	1.3	1.8	2.6	3.6	5.2
10x	0.5	0.7	1	1.4	2
16x	0.2	0.3	0.4	0.5	0.8
25x	0.1	0.1	0.15	0.2	0.3
40x	0.05	0.05	0.05	0.1	0.15

Values will be increased by 35% in transparent media of the eyes.

### Image and magnification data

Setting at magnification changer



	Magnification in plane of the sensor	15 x 22 
6.3x	1.3	2.6
10x	0.5	1
16x	0.2	0.4
25x	0.1	0.15
40x	0.05	0.05

Circles: visible field of the eyepiece.

## Standard settings

The BX 900 has many different adjustments in order to give optimal illumination and exposure. It is best to always start with a standard setting and to make adjustments after each image captured. An example for a standard setting is the diffuse illumination:

1. Main switch on, photo control unit POWER ON and camera body on
2. After waiting a few seconds, set the Flash intensity on HIGH
3. 100% Background illumination 45° angle between microscope and background illumination  
Slit beam vertical  
Slit beam fully open (slit width and height)  
Slit beam centred (screw tightened)  
100% slit illumination (without filter)  
Slit beam covered with the diffusion filter  
Angle between microscope and illumination device  
30° – 45° Magnification 10x Aperture 4 with a sensor rating ISO 500

4. Define the image field, close the left eye (note the difference between eyepiece and photo tube picture)
5. Focus control (eyepiece setting correct?)
6. Capture Image

## Illumination and exposure settings

The following table shows the different settings of illumination and exposure adjustments. This table is also used for practical examples and will give a starting point.

ISO	500 (Standard)			
Flash intensity	high / normal			
BGI* intensity	100%, 50%, 25%, 10%, 5%, 0%, blue filter			
BGI* angle	0° – 90°			
Slit beam	0 (closed) – 8mm (fully open)			
Filter	blue, red free (green), grey 10%, diffused			
Illumination angle	0° – 90°			
Magnification	10x	16x	25x	40x
Aperture	1 – 5			

BGI\* = Background Illumination

## Pictograms

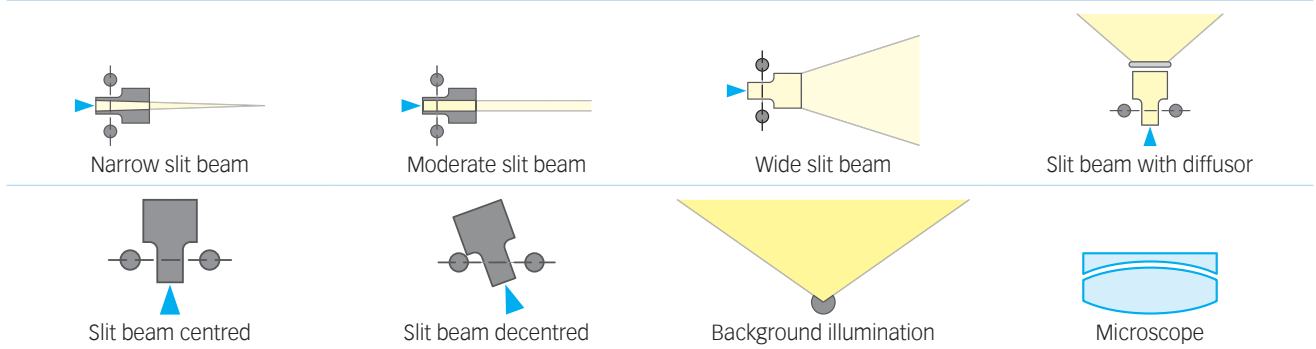

## Diffuse illumination with slit and background illumination

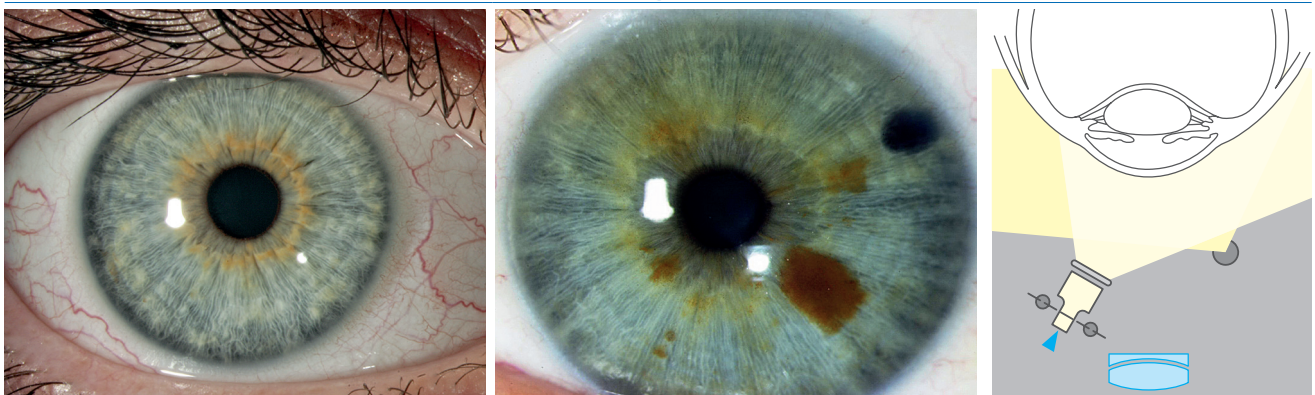

The diffuse illumination with slit beam and background illumination gives a shadow free illumination with natural colors and two light reflexes. This is most useful for low magnification overview images.

ISO	500	BGI angle	30° – 45°	Illumination angle	30° – 45°			
Flash intensity	high	Slit beam	fully open	Magnification	10x	16x	25x	40x
BGI intensity	100%	Filter	diffused	Aperture	4	4	3	2

## Diffuse illumination with background illumination only

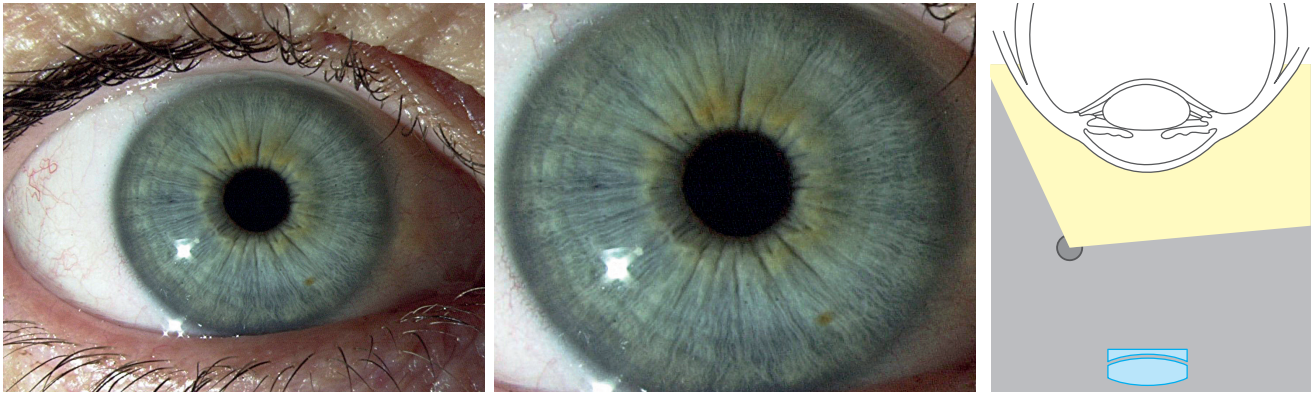

The diffuse illumination with only the background illumination increases the contrast. The structures of the iris are more visible and there is only one light reflex.

ISO	500	BGI angle	30°–45°	Illumination angle	–			
Flash intensity	high	Slit beam	closed	Magnification	10x	16x	25x	40x
BGI intensity	100%	Filter	–	Aperture	4	3	3	2

## Lids – Diffuse illumination



Diffuse illumination provides evenly balanced lighting.

ISO	500	BGI angle	30°–45°	Illumination angle	30°–45°			
Flash intensity	Normal	Slit beam	fully open	Magnification	10x	16x	25x	40x
BGI intensity	50%	Filter	diffused	Aperture	4	4	3	2

## Conjunctiva – Diffuse illumination

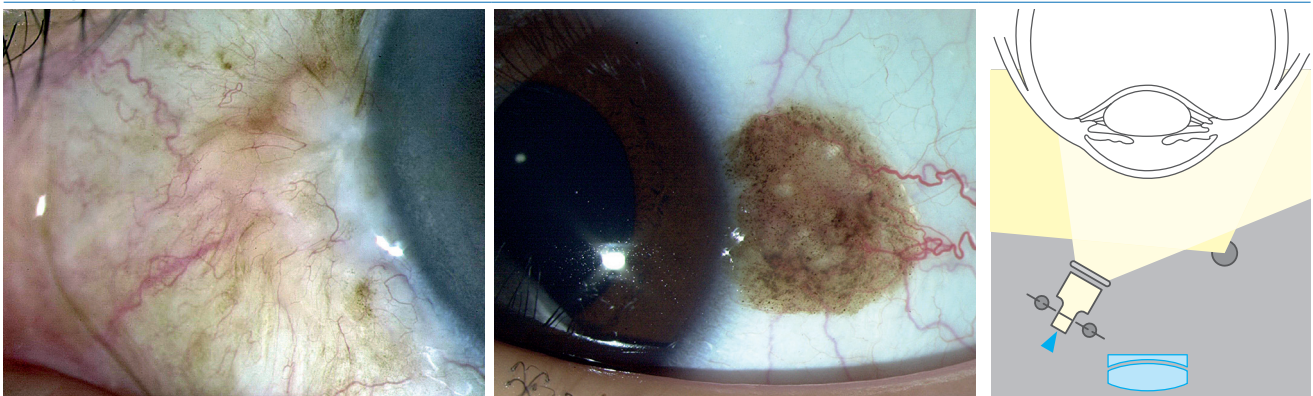

Diffuse illumination provides evenly balanced lighting. Exposure control is more varied due to increased reflectivity.

ISO	500	BGI angle	30°–45°	Illumination angle	30°–45°			
Flash intensity	Normal	Slit beam	fully open	Magnification	10x	16x	25x	40x
BGI intensity	50%	Filter	diffused	Aperture	5	5	4	3

## Conjunctiva – Narrow slit

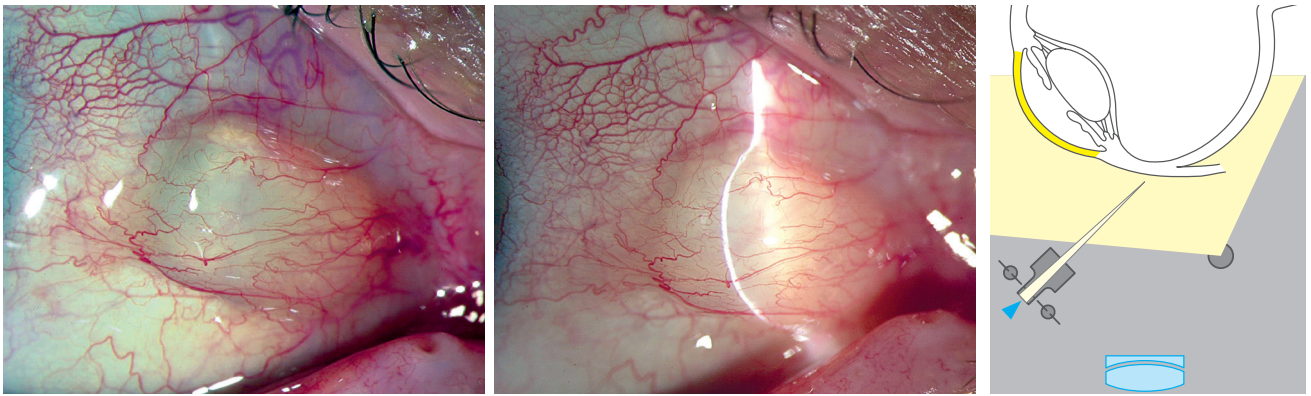

A centred, narrow slit beam projected at a 45° angle demonstrates surface topography and trans-illumination of the lesion. The background illumination gives the position of the slit beam.

ISO	500	BGI angle	30°–45°	Illumination angle	45°			
Flash intensity	high	Slit beam	0.1 mm	Magnification	10x	16x	25x	40x
BGI intensity	10%	Filter	–	Aperture	3	2	2	1

## Conjunctiva – Indirect illumination

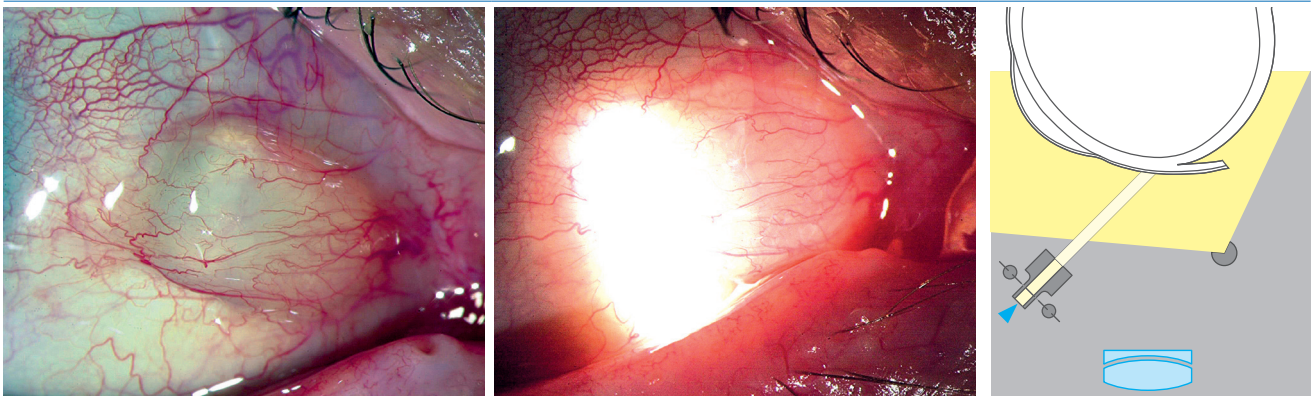

A moderately wide and decentred slit beam is projected just adjacent to the border of the lesion. The light penetrates conjunctiva and illuminates the clear fluid below. In the presence of blood or scar tissue, the light is absorbed.

ISO	500	BGI angle	30°–45°	Illumination angle	decentred			
Flash intensity	high	Slit beam	2–4 mm	Magnification	10x	16x	25x	40x
BGI intensity	10%	Filter	–	Aperture	2	2	1	1

## Cornea – Diffuse illumination

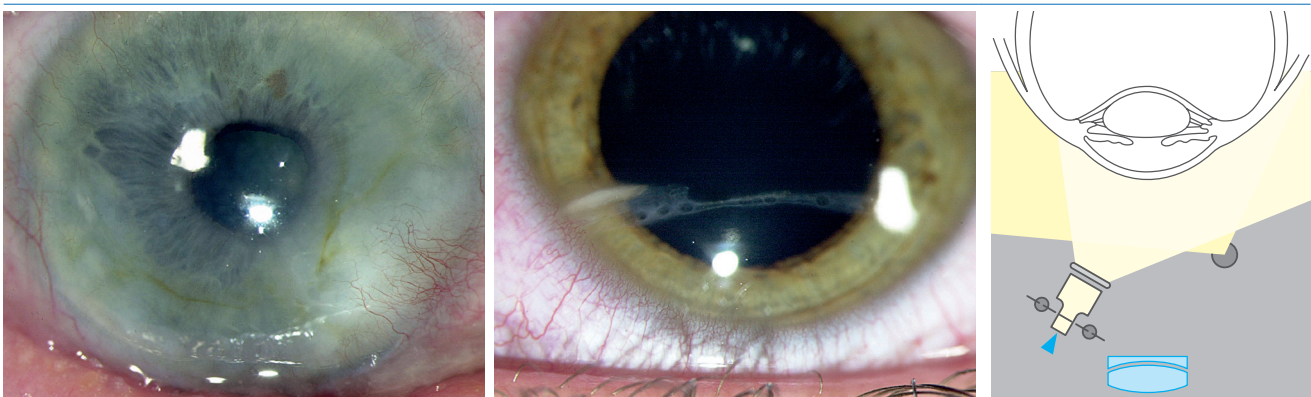

This illumination technique can only be used in the presence of dense corneal pathologies because diffuse light does not penetrate very well through the cornea. Dilating the pupil can enhance pathology by creating a darker background.

ISO	500	BGI angle	30°–45°	Illumination angle	30°–45°			
Flash intensity	high	Slit beam	fully open	Magnification	10x	16x	25x	40x
BGI intensity	100%	Filter	diffused	Aperture	4	4	3	2

## Cornea – Wide slit, tangential illumination

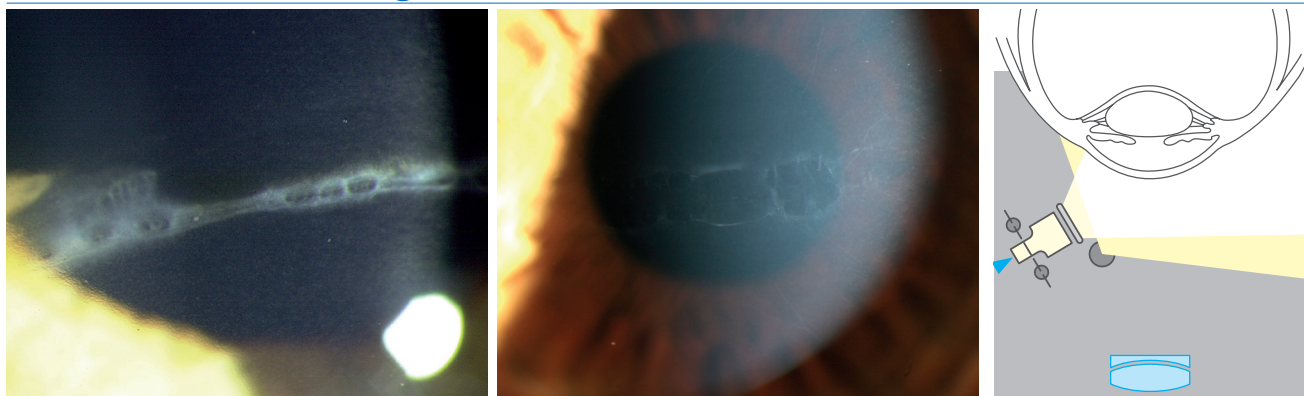

This technique can provide more information as the oblique illumination is reflected and refracted by the cornea and any pathology. Experiment with the illumination angle slit beam width for optimum results.

ISO	500	BGI angle	45°	Illumination angle	60°–80°			
Flash intensity	high	Slit beam	fully open	Magnification	10x	16x	25x	40x
BGI intensity	0–25%	Filter	10%	Aperture	–	4	3	2

## Cornea – Moderate slit

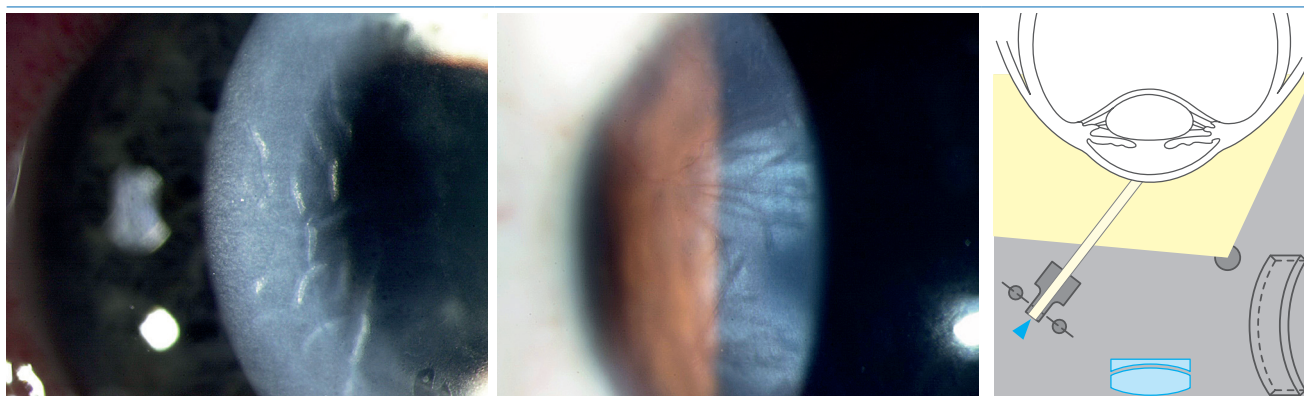

The moderate beam produces two different layers of illumination, one on the epithelium and one on the endothelium. Note the corneal changes are closer to the posterior reflection and therefore they lie deep in the cornea.

ISO	500	BGI angle	30°	Illumination angle	45°			
Flash intensity	high	Slit beam	2–3mm	Magnification	10x	16x	25x	40x
BGI intensity	0–25%	Filter	–	Aperture	–	3	3	2

## Cornea – Narrow slit, optical sectioning

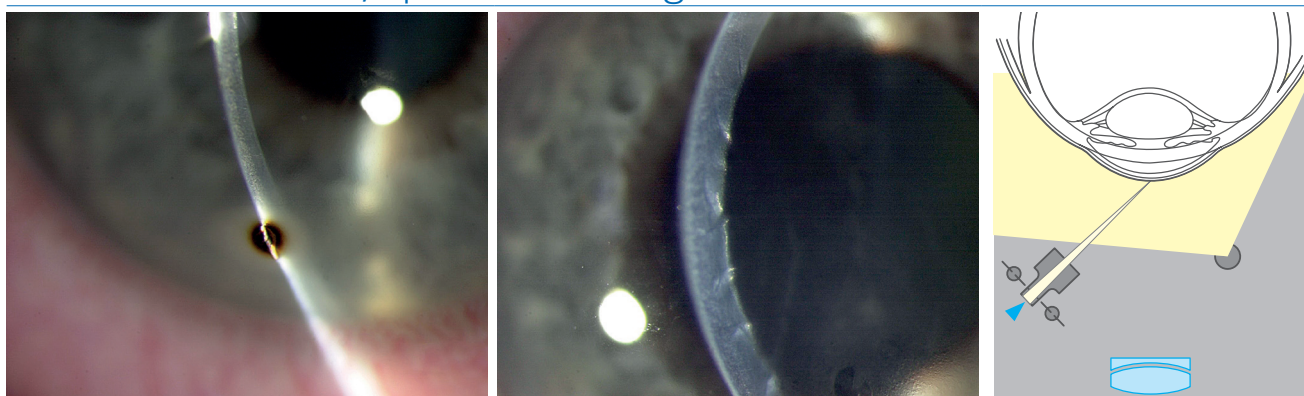

A narrow focal slit beam is projected at a 45° to 60° angle. It cuts an optical section through the cornea like a knife. With this technique it is possible to locate the layer of the pathological changes. These examples demonstrate endothelial and surface pathology.

ISO	500	BGI angle	45°	Illumination angle	60°–90°			
Flash intensity	high	Slit beam	0,1 mm	Magnification	10x	16x	25x	40x
BGI intensity	5%	Filter	–	Aperture	–	2	1	–



## Cornea – Direct retroillumination from the iris

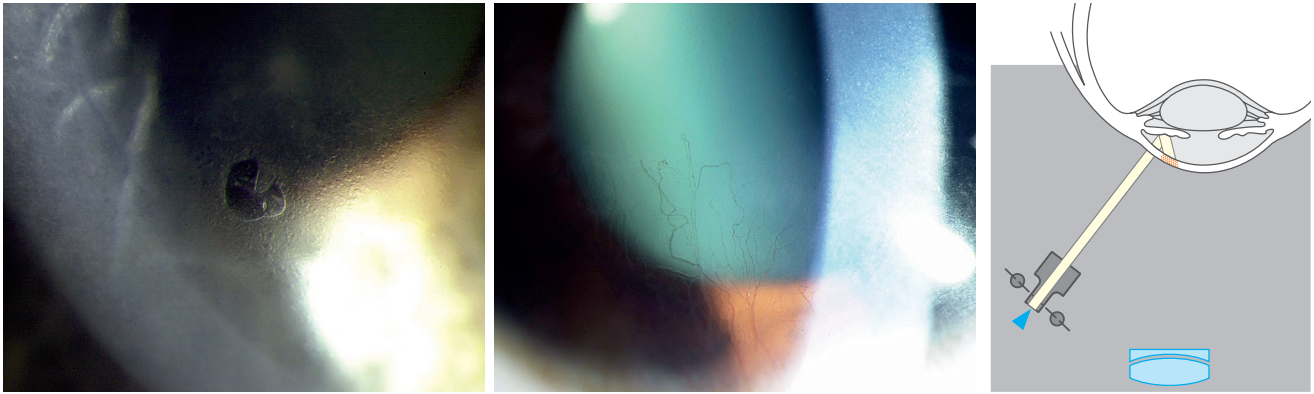

A moderate slit beam is decentred and angled to project onto the iris directly behind the pathology. The light reflects and backlights the cornea. If there is some cataract present the lens can also be used to reflect light directly onto the area of interest.

ISO	500	BGI angle	–	Illumination angle	decentred			
Flash intensity	high	Slit beam	1–2mm	Magnification	10x	16x	25x	40x
BGI intensity	0%	Filter	–	Aperture	–	2	1	1

## Cornea – Indirect retroillumination from the iris

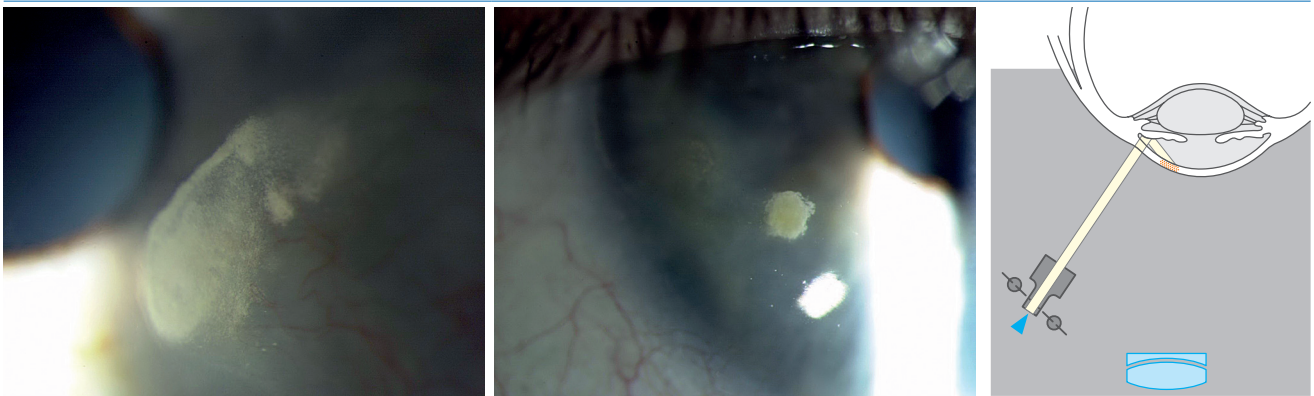

The moderate slit beam is now decentred even more and angled to project onto the iris adjacent to the area behind the area of interest. The background is dark and the edges of non-pigmented lesions are well defined by the diffuse light reflecting from the iris.

ISO	500	BGI angle	–	Illumination angle	decentred			
Flash intensity	high	Slit beam	1–2mm	Magnification	10x	16x	25x	40x
BGI intensity	0–10%	Filter	–	Aperture	–	2	1	1

## Cornea – Sclerotic scatter

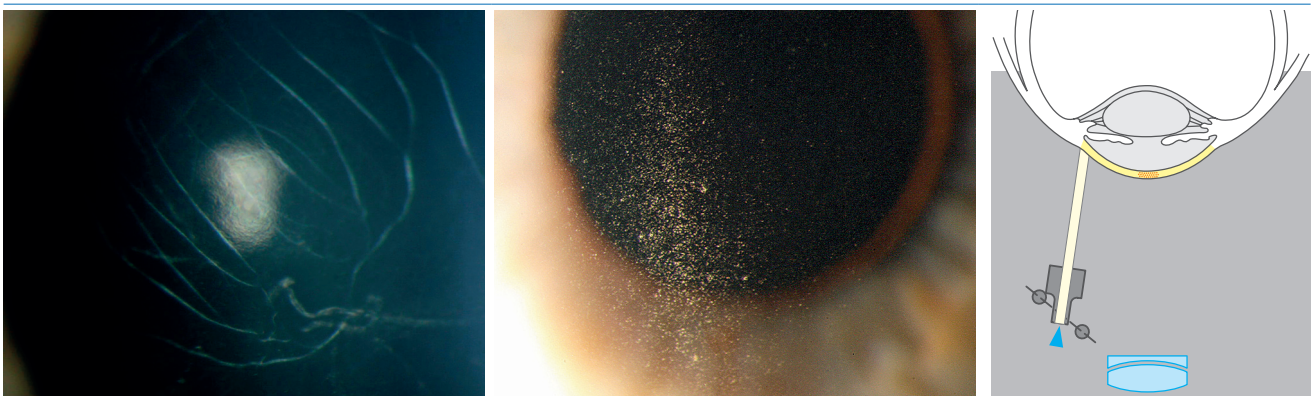

The wide decentred slit beam is projected onto the limbus. The light striking the limbus is internally reflected through the corneal tissue like a fibre optic. Corneal changes or abnormalities can be visualized by reflecting the scattered light. Careful post capture cropping can enhance images.

ISO	500	BGI angle	–	Illumination angle	decentred			
Flash intensity	high	Slit beam	2mm	Magnification	10x	16x	25x	40x
BGI intensity	0%	Filter	–	Aperture	–	2	1	1

## Cornea – Topical administration of Sodium Fluorescein

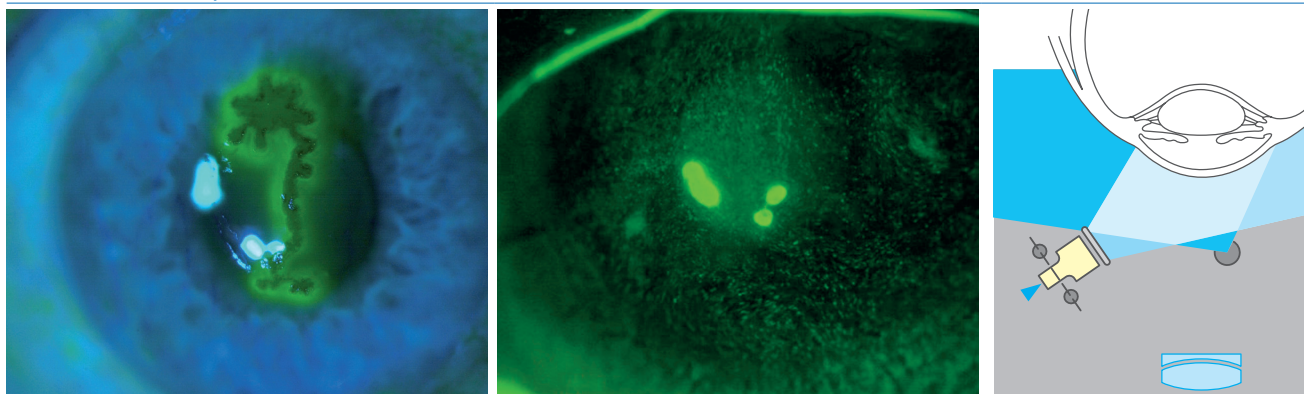

Sodium fluorescein is applied gently to the bulbar conjunctiva. The patient should blink once or twice for the dye to be dispersed over the eye. If the epithelium of the conjunctiva or the cornea is damaged, the fluorescein stains the underlying tissue. The remaining dye fluoresces a yellow green color when excited by the blue light. Healthy epithelium does not stain.

ISO	500	BGI angle	30°	Illumination angle	60°–80°			
Flash intensity	high	Slit beam	fully open	Magnification	10x	16x	25x	40x
BGI intensity	blue filter	Filter	blue filter	Aperture	3	3	2	1

## Anterior chamber – Aqueous flare, Tyndall's phenomenon

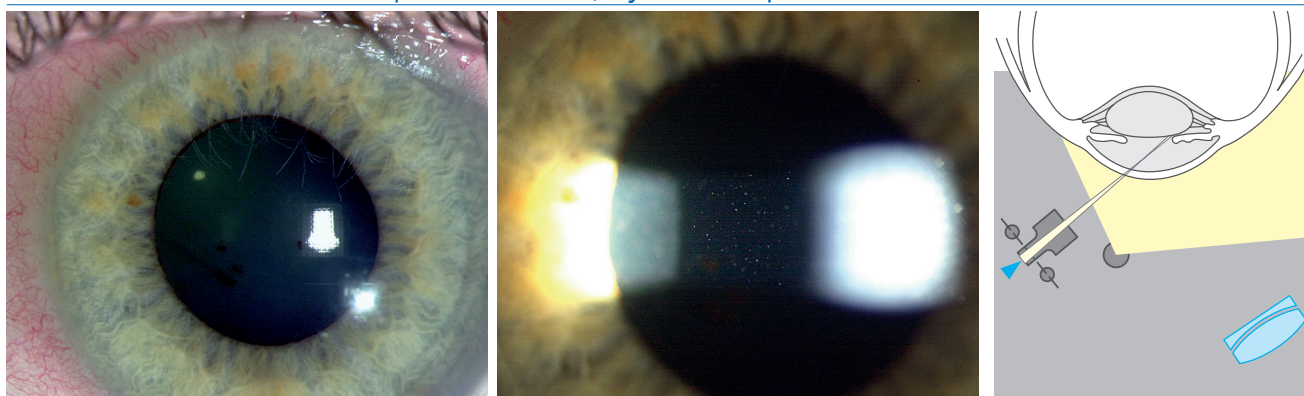

Cells, pigment or proteins in the aqueous humour reflect the light like a faint fog. To visualize this the slit illuminator is adjusted to the smallest circular beam and is projected through the anterior chamber from a 40° to 90° angle. The strongest reflection is possible at 90°.

ISO	500	BGI angle	30°	Illumination angle	50°			
Flash intensity	high	Slit beam	0,1–1 mm	Magnification	10x	16x	25x	40x
BGI intensity	0%–25%	Filter	–	Aperture	–	1	1	1

## Anterior chamber – Goniophotography

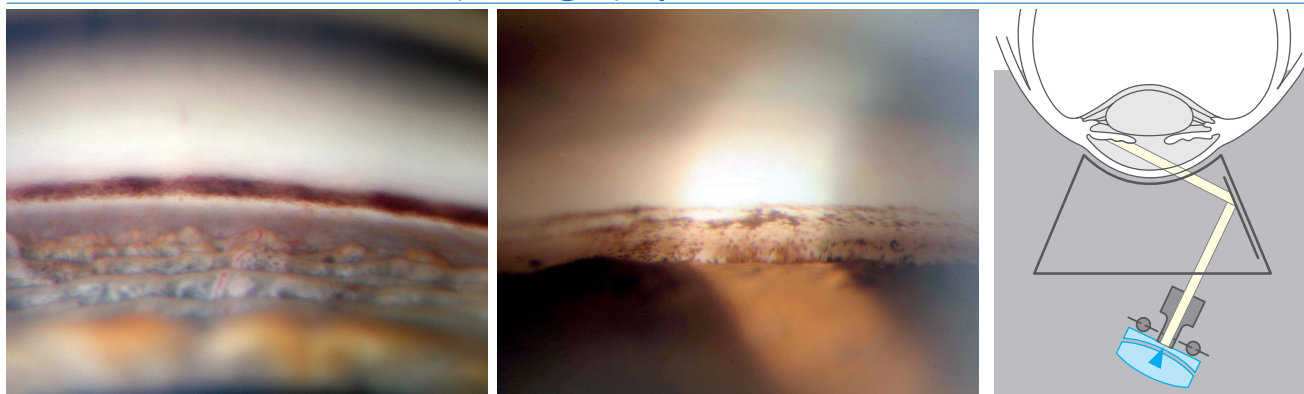

The desired mirror of the gonioscopy lens is positioned opposite to the area of pathology. A wide slit beam is projected in the desired mirror from a near coaxial position to the biomicroscope. Light reflections can be eliminated by tilting the lens.

ISO	500	BGI angle	–	Illumination angle	10°			
Flash intensity	high	Slit beam	2 mm	Magnification	10x	16x	25x	40x
BGI intensity	0%	Filter	–	Aperture	–	5	5	4

## Iris – Wide slit, tangential illumination

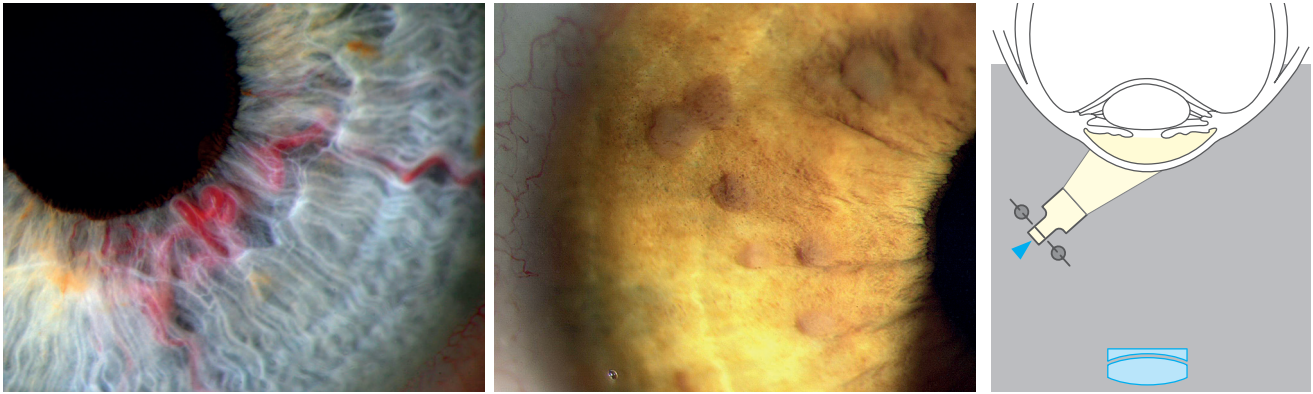

The wide slit beam is projected at an oblique angle of 80° – 90° onto the iris. This illumination creates strong shadows and the surface texture is enhanced. If the headrest doesn't allow a wide oblique angle it is sometimes necessary to turn the patient's head a little away from the light.

ISO	500	BGI angle	45°	illumination angle	80°			
Flash intensity	high	Slit beam	fully open	Magnification	10x	16x	25x	40x
BGI intensity	0%–10%	Filter	–	Aperture	5	5	4	4

## Iris – Transillumination

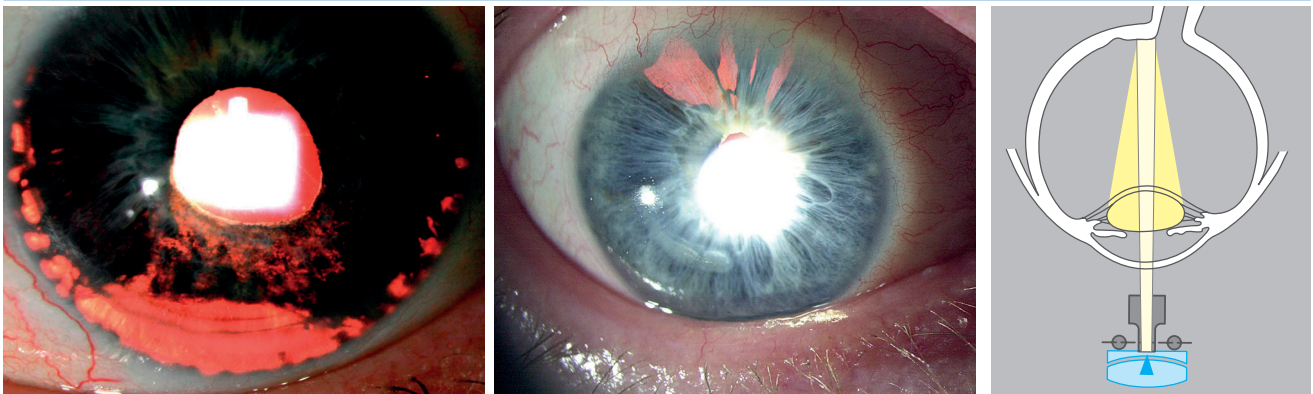

The slit illuminator is positioned coaxially to the biomicroscope and adjusted to provide a small circular beam of light. This beam is projected through the pupil which should be at mid dilation. The light reflects from the fundus and backlights the iris. Normally the iris pigment absorbs the light, but pigmentation defects let the red fundus light pass through.

ISO	500	BGI angle	45°	illumination angle	coaxial			
Flash intensity	high	Slit beam	1–2mm	Magnification	10x	16x	25x	40x
BGI intensity	0%–10%	Filter	–	Aperture	–	2	1	1

## Iris Angiography

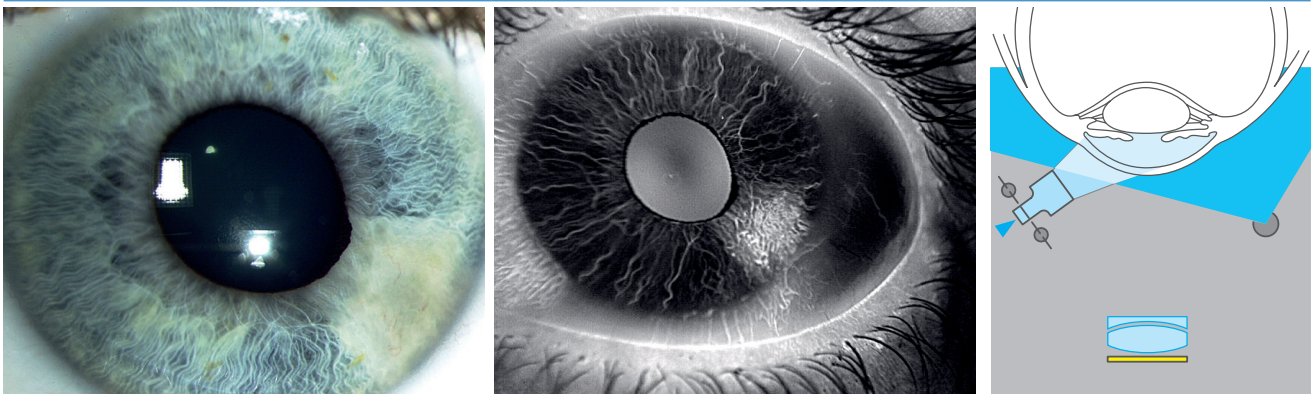

The illumination technique of the iris angiography is like the tangential illumination with the background illumination opposite the slit beam. Both slit illuminator and background illumination have a blue excitation filter. The yellow barrier filter is positioned between the magnification changer and the mirror housing. The barrier filter only works on the image from the right eyepiece which is directed to the camera. Control of the focus of the image during the angiography is possible through the left eyepiece.

ISO	800	BGI angle	45°	illumination angle	45°			
Flash intensity	high	Slit beam	fully open	Magnification	10x	16x	25x	40x
BGI intensity	blue filter	Filter	blue filter	Aperture	–	1	–	–

## Lens – Narrow slit, optical sectioning

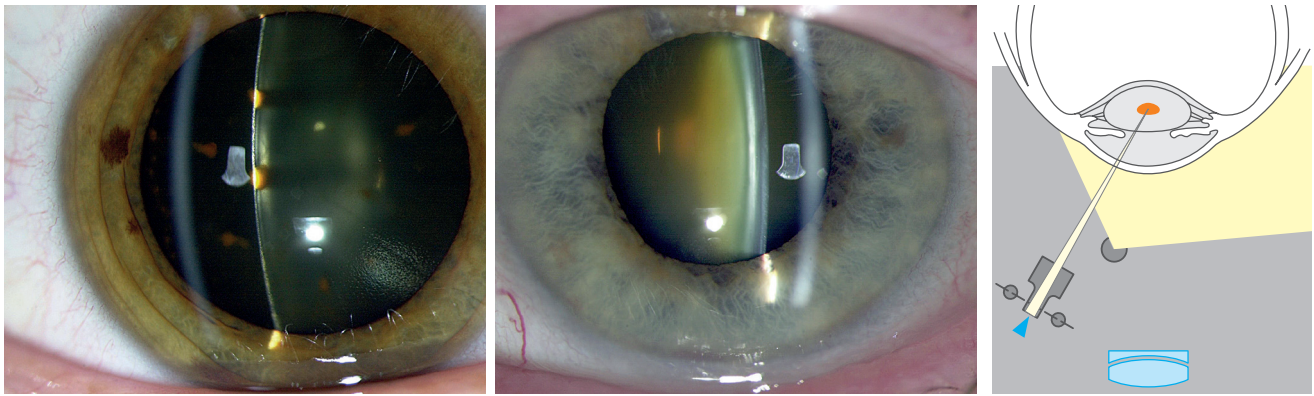

A narrow focal slit beam is projected at a 45° angle to the lens as an optical section is made. Because of the problematic depth of field it is not possible to photograph the entire lens section in focus. It is therefore necessary to focus on the anterior or the posterior lens surface.

ISO	500	BGI angle	45°	Illumination angle	45°				
Flash intensity	high	Slit beam	0.1 mm	Magnification	10x	16x	25x	40x	
Background	25%	Filter	–	Aperture	–	1	1	–	

## Lens – Moderate slit, direct illumination

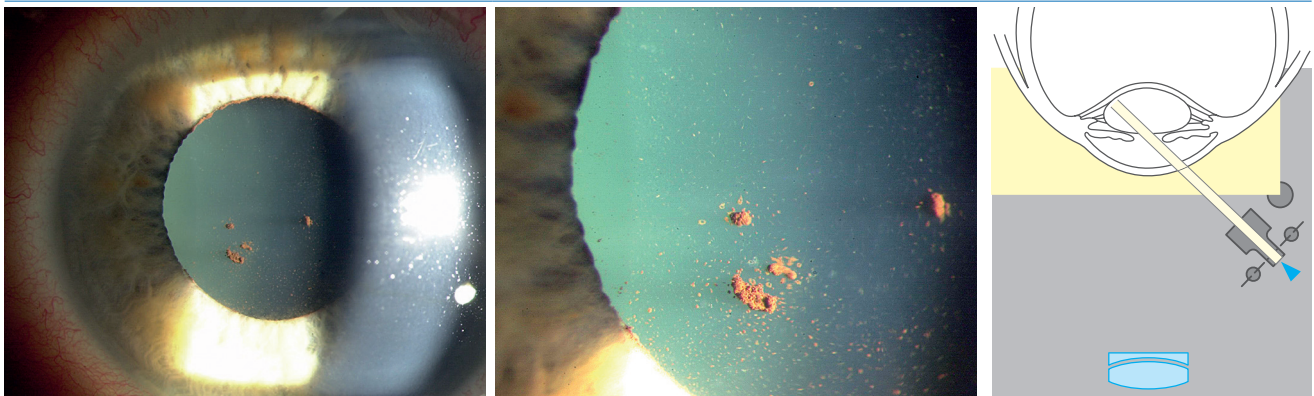

A moderate slit beam is projected at a 45° angle to the lens pathology and is directly illuminated. Dilatation of the pupil is required for effective imaging.

ISO	500	BGI angle	45°	Illumination angle	45°				
Flash intensity	high	Slit beam	2–4 mm	Magnification	10x	16x	25x	40x	
Background	10%	Filter	–	Aperture	–	2	2	1	

## Lens – Moderate slit, tangential illumination

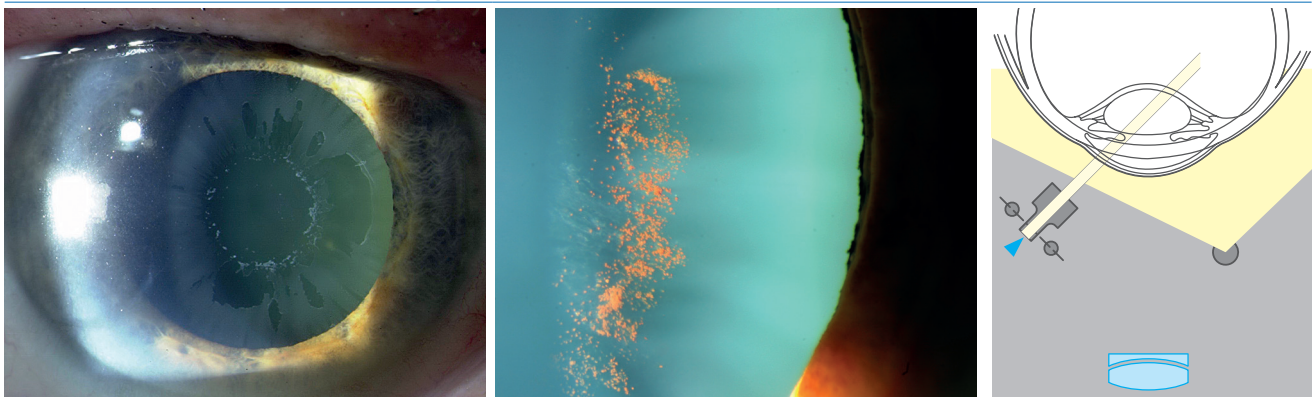

A moderate to wide slit beam is projected at an angle greater than 45 degrees to provide oblique tangential illumination that can enhance detail by providing shadows. Pupil dilation will aid this illumination technique.

ISO	500	BGI angle	45°–60°	Illumination angle	45°–60°				
Flash intensity	high	Slit beam	2–6 mm	Magnification	10x	16x	25x	40x	
Background	10%	Filter	–	Aperture	–	2	2	1	

## Lens – Retroillumination, red-reflex photography

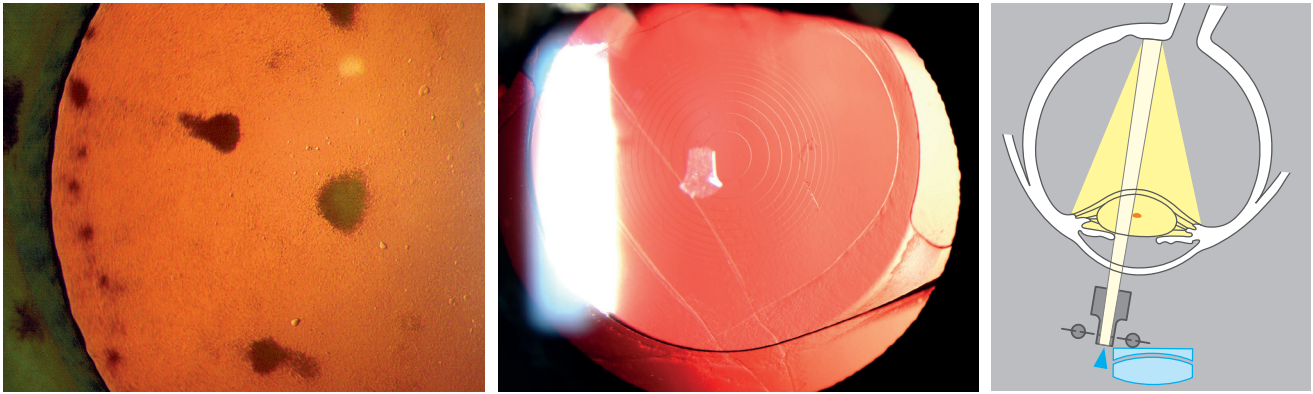

The slit illuminator is positioned in an almost coaxial position with the biomicroscope. A wide slit beam is decentered and adjusted to a half circle by using the slit width and height controls. The decentered slit beam is projected near the pupil margin through a dilated pupil. Careful composition can minimise the direct reflection.

ISO	500	BGI angle	–	Illumination angle	decentred			
Flash intensity	high	Slit beam	2 mm	Magnification	10x	16x	25x	40x
Background	0%	Filter	–	Aperture	–	2	1	1

## Vitreous – Narrow slit

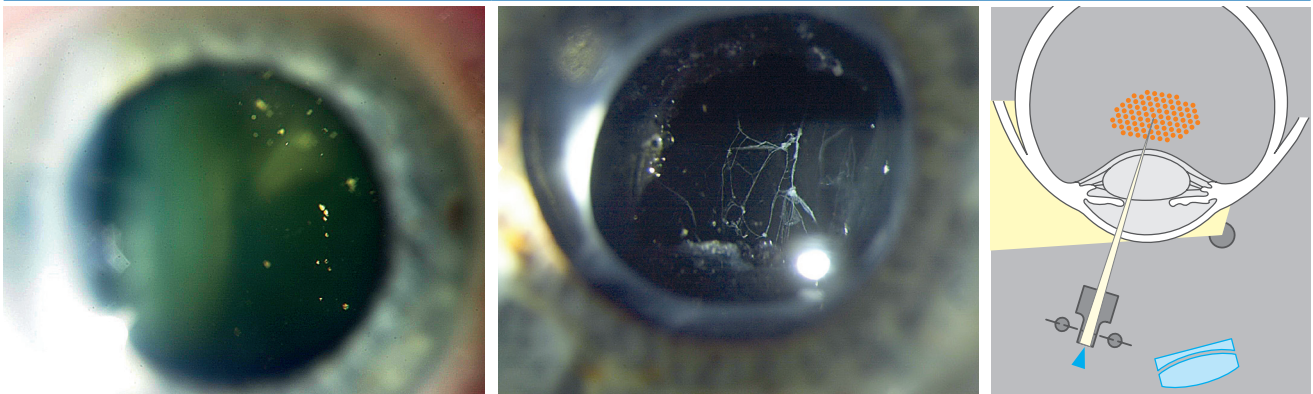

Without diagnostic lenses it is only possible to examine and to document the anterior part of the vitreous. Anterior Vitreous pathology can be seen with a narrow slit beam. Only when the dioptric power of the eye is reduced is it possible to focus more posteriorly.

ISO	500	BGI angle	45°	Illumination angle	45°			
Flash intensity	high	Slit beam	0,1–1,0 mm	Magnification	10x	16x	25x	40x
Background	0%–10%	Filter	–	Aperture	–	1	1	–

## Fundus – Central retina with a three-Mirror contact lens

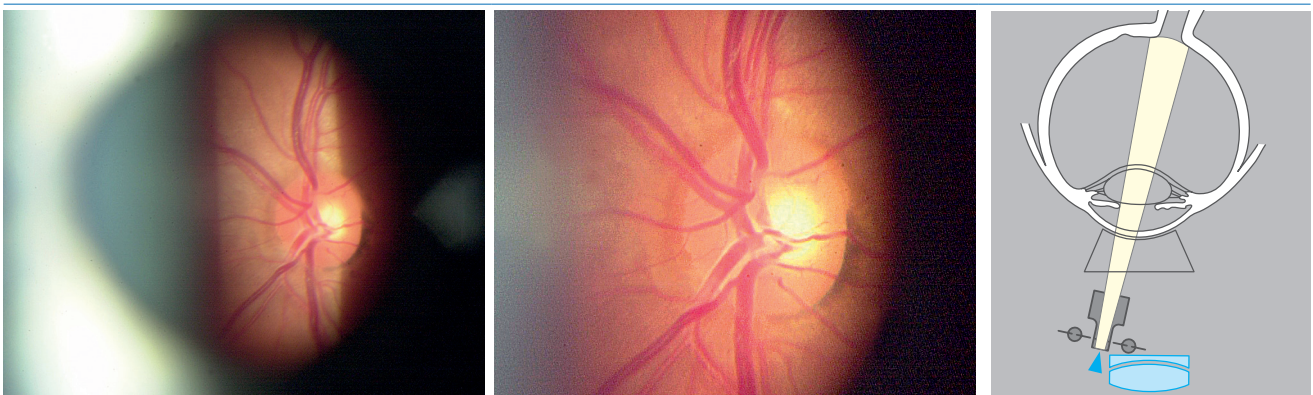

The slit illuminator is positioned in an almost coaxial position with the biomicroscope. A wide slit beam is decentered and adjusted to a half circle by using the slit width and height controls. The decentered slit beam is projected near the pupil margin through a dilated pupil. Careful composition can minimise the direct reflection.

ISO	500	BGI angle	–	Illumination angle	5°–10°			
Flash intensity	high	Slit beam	2 mm	Magnification	10x	16x	25x	40x
Background	0%	Filter	10%	Aperture	–	2	1	1

## Fundus – Central retina with a 90-diopter lens

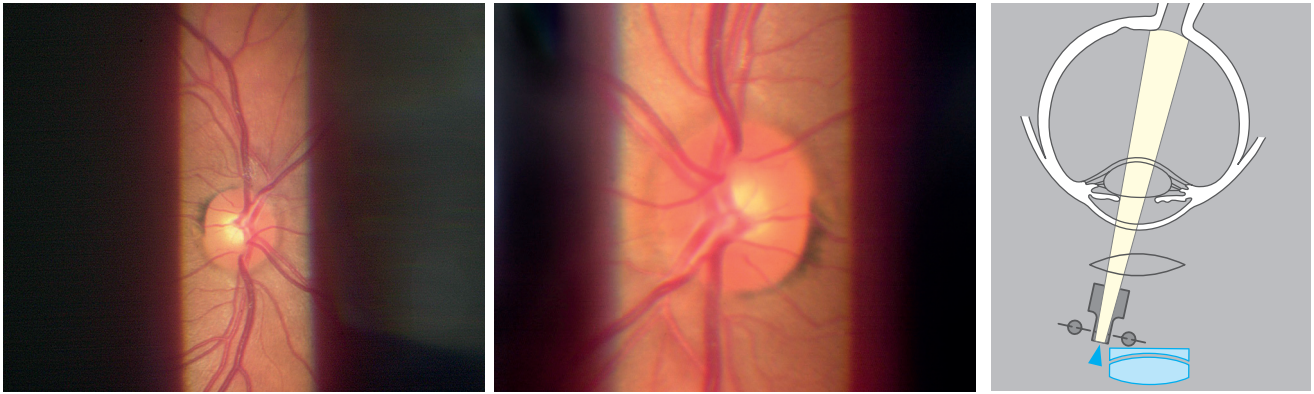

Without diagnostic lenses it is only possible to examine and to document the anterior part of the vitreous. Anterior Vitreous pathology can be seen with a narrow slit beam. Only when the dioptric power of the eye is reduced is it possible to focus more posteriorly.

ISO	500	BGI angle	–	Illumination angle	5°–10°			
Flash intensity	high	Slit beam	2mm	Magnification	10x	16x	25x	40x
Background	0%	Filter	10%	Aperture	–	2	1	–

### **Recommended Reading**

Clinical Slit lamp Biomicroscopy and Photo Slit lamp Biomicrography / Martonyi, Bahn & Meyer

Time One Ink, Ltd. / Sedona, AZ

Copies of this and other books of interest to the Ophthalmic Photographer can be found at:  
[www.twinchimney.com](http://www.twinchimney.com)

### **Photos by:**

Cees van Beek / Leyenburg Hospital, Den Haag, Netherlands

Tarek Shaarawy / University Hospital of Geneva, Switzerland

Haag-Streit, Bern, Switzerland

John McCormick / Tennent Institute of Ophthalmology University of Glasgow, Scotland

### **Haag-Streit educational video**

Haag-Streit has produced a short movie which helps you to get the most out of your new camera.



Watch the video

Visit our homepage under [www.haag-streit.com](http://www.haag-streit.com)

**HAAG-STREIT AG**

Gartenstadtstrasse 10

3098 Koeniz

Switzerland

Phone +41 31 978 01 11

Fax +41 31 978 02 82

[info@haag-streit.com](mailto:info@haag-streit.com)

[www.haag-streit.com](http://www.haag-streit.com)